



**Rodney  
Industries**

A Division of Vinidex Pty Limited

**PIPE & FITTINGS**

# SEWER & CIVIL



**Rodney Industries**

A Division of Vinidex Pty Limited





Phone:  
Email:  
Web:

07 3624 0300  
sales@rodneyind.com.au  
www.rodneyind.com.au

# FROM FACTORY TO FIELD



# INDEX

	<b>Sewertech</b>	<b>PAGE 01</b>
	<b>StormPro</b>	<b>PAGE 09</b>
	<b>Maxi Stubs</b>	<b>PAGE 15</b>
	<b>Ductile Iron Pipe</b>	<b>PAGE 17</b>

# SEWERTECH

## SEWERTECH

Sewertech is dual wall co-extruded black or light grey high density polyethylene pipe and is the latest combination of raw materials and pipeline design technology. It is the first-ever purpose built pipe for pipe bursting and slip lining applications and is designed specifically for the waste-water industry, making it most suitable for gravity sewerage and drainage applications.

The black external layer provides high scratch and UV resistance, while the light coloured internal layer provides good reflection properties for manual and video inspection purposes.

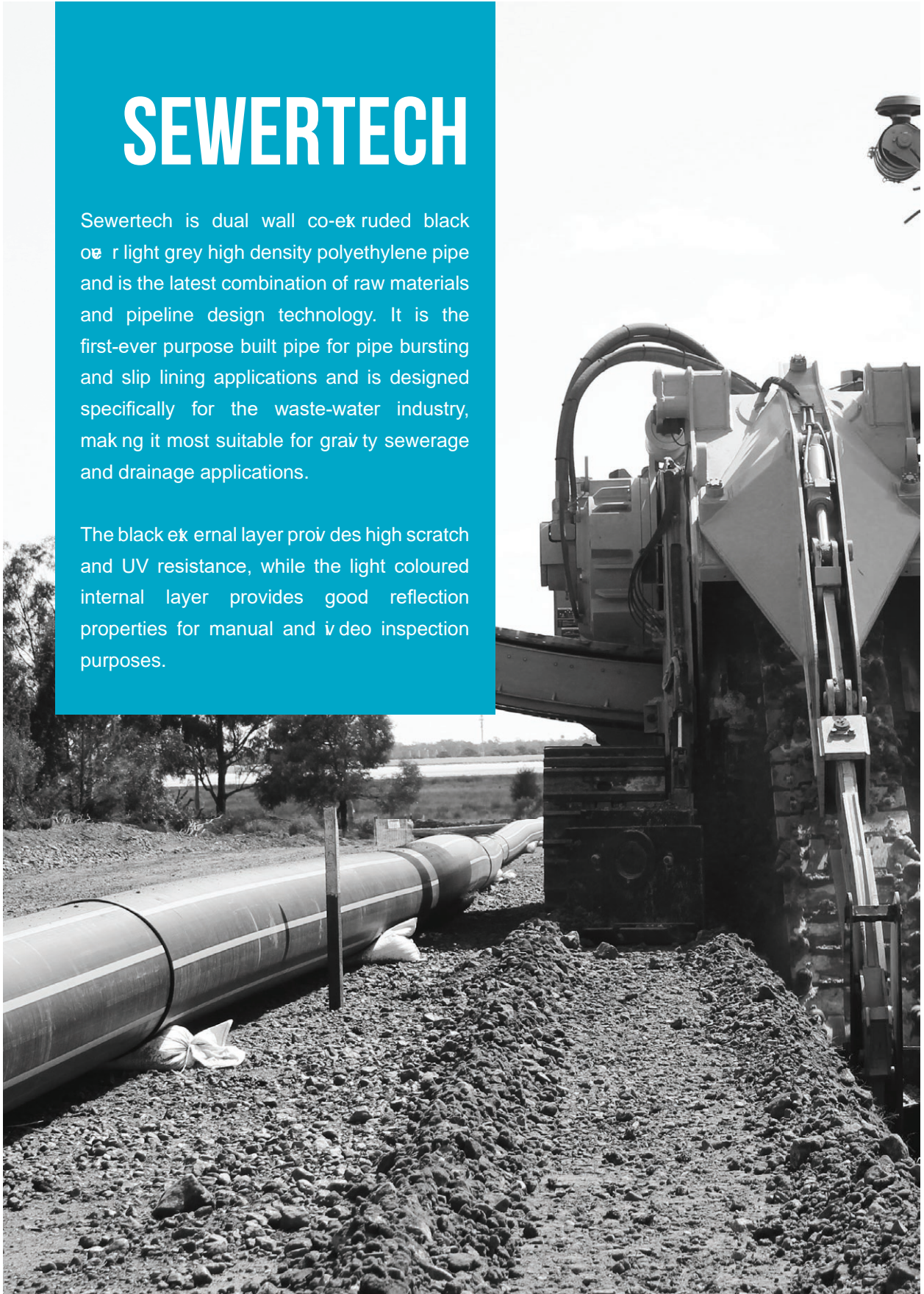

# BENEFITS

- High tensile strength to withstand installation forces
- Low friction external surface for ease of insertion
- Low friction internal surface for hydraulic efficiency and low residual slime growth
- Scratch and ultra-violet resistant external PE layer
- Can be installed by slip lining, pipe bursting, directional drilling or direct burial
- Zero joint infiltration, zero root penetration.

# JOINTING

Sewertech can be joined by butt-fusion and electrofusion welding using standard PE jointing equipment and electrofusion fittings.

# COMPATIBILITY

Sewertech is compatible with all standard PE sewer fittings and is suitable for use with a wide range of off the shelf couplings, 45° saddles and various angle bends. Property connections can be made easily using standard saddles or junctions.

# PIPE SPECS

Nom Dia. DN (mm)	Mean Outside Diameter		Wall Thickness SDR21	
	Min.	Max	Min.	Max
160	160	161.5	7.7	8.6
180	180	181.7	8.6	9.6
250	250	252.3	11.9	13.2
315	315	317.9	15	16.6





# THE PRODUCTS

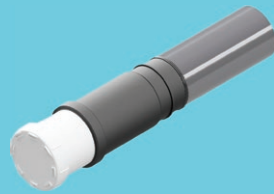

PE Adaptor & PVC Socket and Cap



380mm Radius Sweep Bend 45°



480mm Radius Sweep Bend 90°



750mm Radius Sweep Bend 15°



750mm Radius Sweep Bend 30°



750mm Radius Sweep Bend 45°



750mm Radius Sweep Bend 90°



90° Sweep Junctions Reducing



90° Sweep Junctions Equal

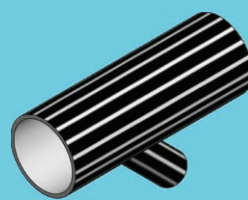

45° Junctions Reducing

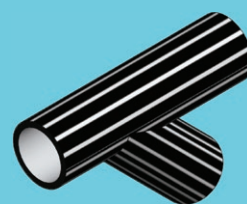

45° Junctions Equal

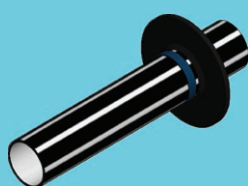

Spigot fitted with Hydrophilic Seal

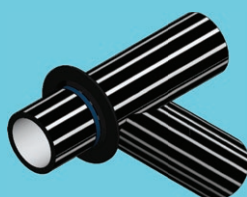

External 45° Backdrop Junction with Seal

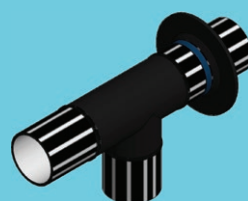

External 90° Backdrop Junction with Seal



External Backdrop Bend with Seal

# SEWERTECH

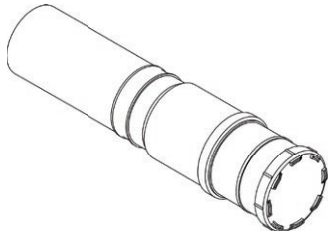

### PE Adaptor & PVC Socket and Cap

Code	PE Size (mm)	PVC Size (mm)
PEADPVC110	110	100
PEADPVC160	160	150

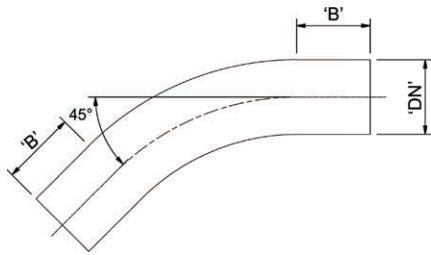

### SewerTech® 380mm Radius Sweep Bends 45°

Code	Nom Dia. DN (mm)	Dim. (mm) 'B' (min.)
STSW11045380R	110	110
STSW11030380R	110	110
STSW11090380R	110	110

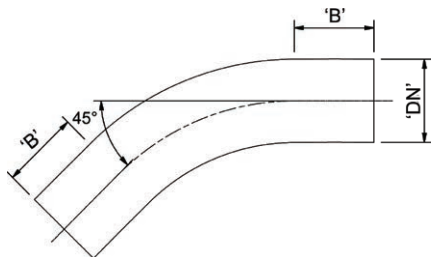

### SewerTech® 480mm Radius Sweep Bends 45°

Code	Nom Dia. DN (mm)	Dim. (mm) 'B' (min.)
STSW16045480R	160	160
STSW16090480R	160	160



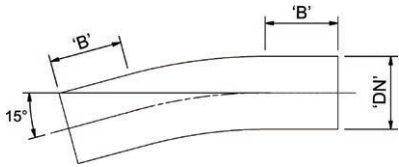

SewerTech® 750mm Radius Sweep Bends 15°

Code	Nom Dia. DN (mm)	Dim. (mm) 'B' (min.)
STSW11015750R	110	110
STSW16015750R	160	160

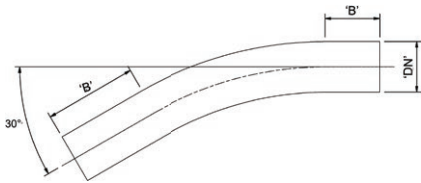

SewerTech® 750mm Radius Sweep Bends 30°

Code	Nom Dia. DN (mm)	Dim. (mm) 'B' (min.)
STSW11030750R	110	110
STSW16030750R	160	160

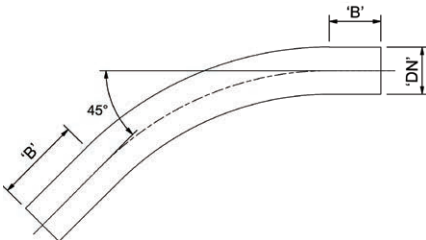

SewerTech® 750mm Radius Sweep Bends 45°

Code	Nom Dia. DN (mm)	Dim. (mm) 'B' (min.)
STSW11045750R	110	110
STSW16045750R	160	160

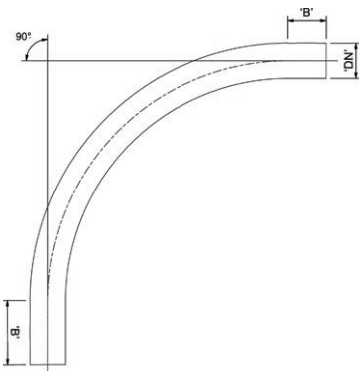

SewerTech® 750mm Radius Sweep Bends 90°

Code	Nom Dia. DN (mm)	Dim. (mm) 'B' (min.)
STSW11090750R	110	110
STSW16090750R	160	160

# SEWERTECH

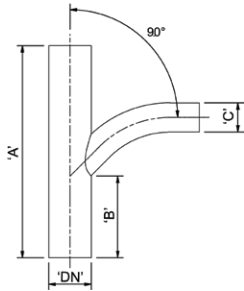

SewerTech® 90° Sweep Junctions Reducing

Code	Nom Dia. DN (mm)	Dim. (mm) 'A'	Dim. (mm) 'B'	Dim. (mm) 'C'
STSJR16011090	160	600	310	110
STSJR25011090	250	800	310	110
STSJR25016090	250	800	310	160

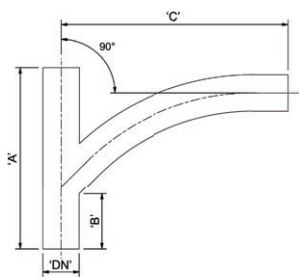

SewerTech® 90° Sweep Junctions Equal

Code	Nom Dia. DN (mm)	Dim. (mm) 'A'	Dim. (mm) 'B'	Dim. (mm) 'C'
STSJE11090	110	540	252	455
STSJE16090	160	800	242	1000

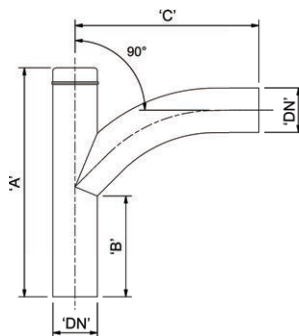

SewerTech® 90° Sweep Junctions Equal c/w low pressure end cap butt welded

Code	Nom Dia. DN (mm)	Dim. (mm) 'A'	Dim. (mm) 'B'	Dim. (mm) 'C'
STSJE11090CAP	110	569	252	455

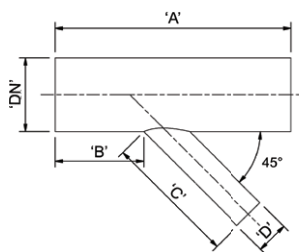

SewerTech® 45° Junctions Reducing

Code	Nom Dia. DN (mm)	Dim. (mm) 'A'	Dim. (mm) 'B'	Dim. (mm) 'C'	Dim. (mm) 'D'
STJR16011045	160	800	275	440	110
STJR25011045	250	800	360	450	110
STJR25016045	250	800	360	550	160

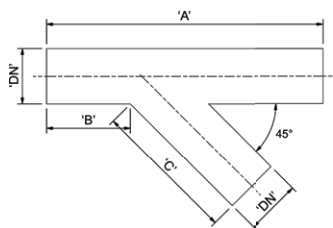

SewerTech® 45° Junctions Equal

Code	Nom Dia. DN (mm)	Dim. (mm) 'A'	Dim. (mm) 'B'	Dim. (mm) 'C'
STJE11045	110	800	252	425
STJE16045	160	800	242	450

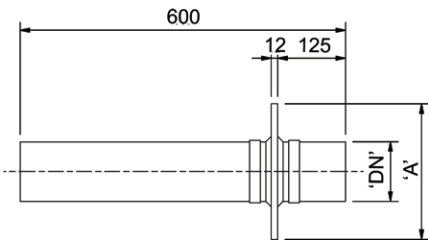

Puddle Flange MH Spigot

Code	Nom Dia. DN (mm)	Dim. (mm) 'A'
PF110MHS250	110	250
PF160MHS300	160	300
PF250MHS390	250	390
PF315MHS455	315	455

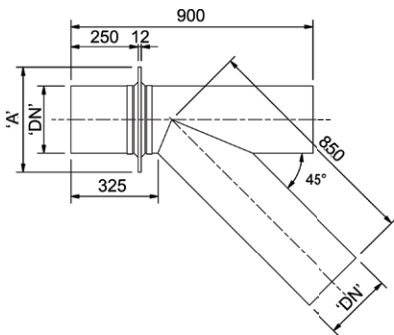

Puddle Flange External 45° Backdrop Junction

Code	Nom Dia. DN (mm)	Dim. (mm) 'A'
PF160BJ45	160	300
PF250BJ45	250	390

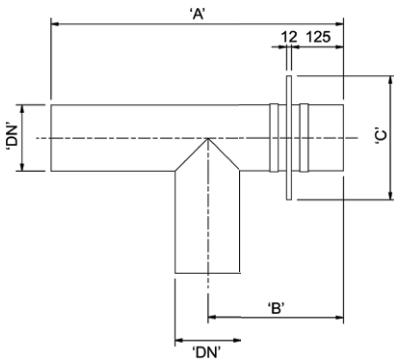

Puddle Flange External 90° Backdrop Junction

Code	Nom Dia. DN (mm)	Dim. (mm) 'A'	Dim. (mm) 'B'	Dim. (mm) 'C'
PF110BJ90	110	685	305	250
PF160BJ90	160	710	330	300
PF250BJ90	250	780	470	390
PF315BJ90	315	938	580	455

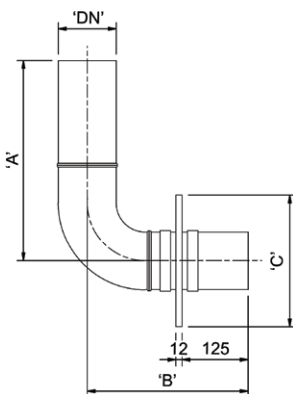

Puddle Flange Backdrop Bend

Code	Nom Dia. DN (mm)	Dim. (mm) 'A'	Dim. (mm) 'B'	Dim. (mm) 'C'
PF110BB90	110	380	305	250
PF160BB90	160	380	330	300
PF250BB90	250	570	470	390
PF315BB90	315	580	580	455

# STORMPRO

STORMPRO

## STORMPRO

StormPRO pipes have a simple and effective rubber ring joint system which is easy to assemble, leak tight and protects against tree root intrusion. The rubber ring is located on the spigot in the last trough between the corrugations.

Vinidex PRO2 is a new jointing system designed for easier installation and leak tight joint performance. The PRO2 joint design uses a new redesigned rubber ring to match new socket geometry. Ensure that only PRO2 rubber rings are used with PRO2 sockets. PRO2 sockets can be identified by a label on the socket and PRO2 rubber rings can be identified by PRO2 marking on the ring.



## BENEFITS

- Wide range of fittings available including Tees, Bends and Junctions.
- StormPRO® pipes are twin-wall, corrugated polypropylene pipes for non-pressure applications.
- Manufactured with a smooth bore for optimum hydraulic performance and a corrugated outside wall for high stiffness to weight ratio.
- Latest generation PRO2 Joints.
- Light weight.

# THE PRODUCTS



PRO Coupling



PRO Slip Coupling



PRO Push on Cap



PRO Bend 30°



PRO Bend 45°



PRO Bend 88°



PRO Equal Tee



PRO Reducing Tee



PRO Equal Junction 45°



PRO Equal Junction 88°



PRO Step Down Junction 45°



PRO Step Down Junction 88°

# STORMPRO



PRO Coupling Polypropylene

Code	Size (mm)	Spigot
SWPC450	450	FF
SWPC525	525	FF
SWPC600	600	FF



PRO Slip Coupling Polypropylene

Code	Size (mm)	Spigot
PROSC450	450	FF
PROSC525	525	FF
PROSC600	600	FF
PROSC750*	750	-
PROSC900*	900	-

\* Minimum order quantity is 3



PRO Push on Cap Polypropylene

Code	Size (mm)	Spigot
SWPPOC450	450	F
SWPPOC525	525	F
SWPPOC600	600	F



Pro Bend 30° Polypropylene

Code	Size (mm)	Spigot	SN
SWPB45030MF	450	MF	10
SWPB60030MF	600	MF	10



Pro Bend 45° Polypropylene

Code	Size (mm)	Spigot	SN
SWPB45045MF	450	MF	10
SWPB52545MF	525	MF	10
SWPB60045MF	600	MF	10
SWPB75045MF	750	MF	10
SWPB90045MF	900	MF	10



Pro Bend 88° Polypropylene

Code	Size (mm)	Spigot	SN
SWPB45088MF	450	MF	10
SWPB52588MF	525	MF	10
SWPB60088MF	600	MF	10
SWPB75088MF	750	MF	10
SWPB90088MF	900	MF	10

# STORMPRO



PRO Equal Tee Polypropylene

Code	Size (mm)	Spigot	SN
SWPET450MFF	450	MFF	10
SWPET525MFF	525	MFF	10
SWPET600MFF	600	MFF	10
SWPET750MFF	750	MFF	10
SWPET900MFF	900	MFF	10



PRO Reducing Tee Polypropylene

Code	Size (mm)	Size (mm)	Spigot	SN
SWPRT450150MF	450	150	MF	10
SWPRT450225MF	450	225	MF	10
SWPRT450300MF	450	300	MF	10
SWPRT450375MF	450	375	MF	10







Pro Equal Junction 45° Polypropylene

Code	Size (mm)	Spigot	SN
SWPEJ45045MFF	450	MFF	10
SWPEJ52545MFF	525	MFF	10
SWPEJ60045MFF	600	MFF	10
SWPEJ75045MFF	750	MFF	10
SWPEJ90045MFF	900	MFF	10



Pro Equal Junction 88° Polypropylene

Code	Size (mm)	Spigot	SN
SWPEJ45088MFF	450	MFF	10
SWPEJ52588MFF	525	MFF	10
SWPEJ60088MFF	600	MFF	10
SWPEJ75088MFF	750	MFF	10



Pro Step Down Junction 45° Polypropylene

Code	Size (mm)	Size (mm)	Spigot	SN
SWPSDJ45015045MFF	450	150	MF	10
SWPSDJ45022545MF	450	225	MF	10
SWPSDJ45030045MFF	450	300	MF	10
SWPSDJ45037545MF	450	375	MF	10



Pro Step Down Junction 88° Polypropylene

Code	Size (mm)	Size (mm)	Spigot	SN
SWPSDJ45015088MFF	450	150	MF	10
SWPSDJ45022588MF	450	225	MF	10
SWPSDJ45030088MF	450	300	MF	10
SWPSDJ45037588MFF	450	375	MF	10

# MAXI STUBS

MAXI STUBS

## MAXI STUBS

The MaxiStub is a Polyethylene (PE) flange system that is full faced with a full nominal bore.

The Mak Stub was developed so that the flange size and the nominal bore of PE pipes could be closely matched to other pipe materials at higher PN Ratings.

Originally designed for municipal requirements (PN16 pipes), the flange system is now standard on the range of Rodney Industries' Poly Footvalves, Leaf and Lint Strainers and is appearing on more and more Suction Lines, addressing the bore size issues so critical to flow velocities.



## THE DIFFERENCE

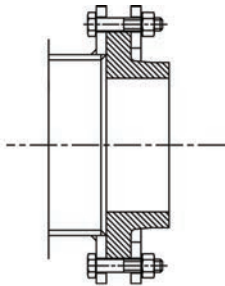

### CONVENTIONAL POLY STUB FLANGE

Steel Flange to Conventional Poly Stub Flange and Backing Ring (Table D)

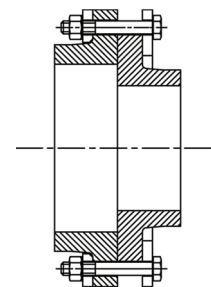

### MAXI STUB FLANGE & BACKING RING

MaxiStub Flange & Backing Ring to Conventional Poly Stub Flange & Backing Ring (Table D)

# BENEFITS

- Full nominal bore at high pressure ratings on any flange size.
- No spacers required for butterfly valve function.
- Full sealing face with full backing flange support.
- No deformation of stubs or backing rings.
- Backing rings captured by welds.
- Standard pressure rating of PN16/SDR11 up to 375mm available; others available on request.
- Suitable for butt welding or electrofusion.

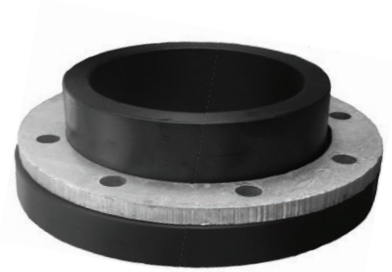

## MAXI STUB GUIDE

Flange & Nominal Bore Size		Polyethylene Pipe Sizes to suit MAXI Stub	Standard Reference of Typical Pipes ie. PVC S1&S2, Steel, Ductile
inch	mm		
3"	80	90 / 110	80
4"	100	125 / 140	100
5"	125	140 / 160	125
6"	150	180 / 200	150
8"	200	225 / 250	200
9"	225	250 / 280	225
10"	250	280 / 315	250
12"	300	355	300

Maxi Stub Assembly complete with Stainless Steel 316 Backing Ring

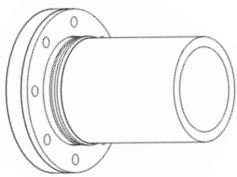

Code	Pipe Ø	inches	mm	OD mm
MX309011EFASSY	90	3	80	185
MX412511EFASSY	125	4	100	215
MX618011EFASSY	180	6	150	280
MX620011EFASSY	200	6	150	280
MX822511EFASSY	225	8	200	335
MX825011EFASSY	250	8	200	335
MX928011EFASSY	280	9	225	370
MX1031511EFASSY	315	10	250	405
MX1235511EFASSY	355	12	300	455

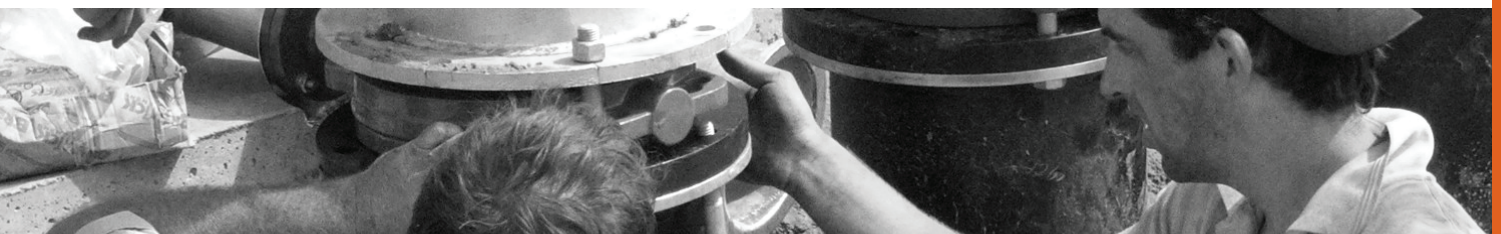

## DUCTILE IRON PIPE

# DUCTILE IRON PIPE

At Rodney Industries we now offer a range of Ductile Iron Pipe.

Lengths can be manufactured to suit job requirement with the following DN sizes available:

- DN100
- DN150
- DN200

With a bitumen coating for long term corrosion resistance our pipe is manufactured to Flange Table AS4087 PN 16 standard.

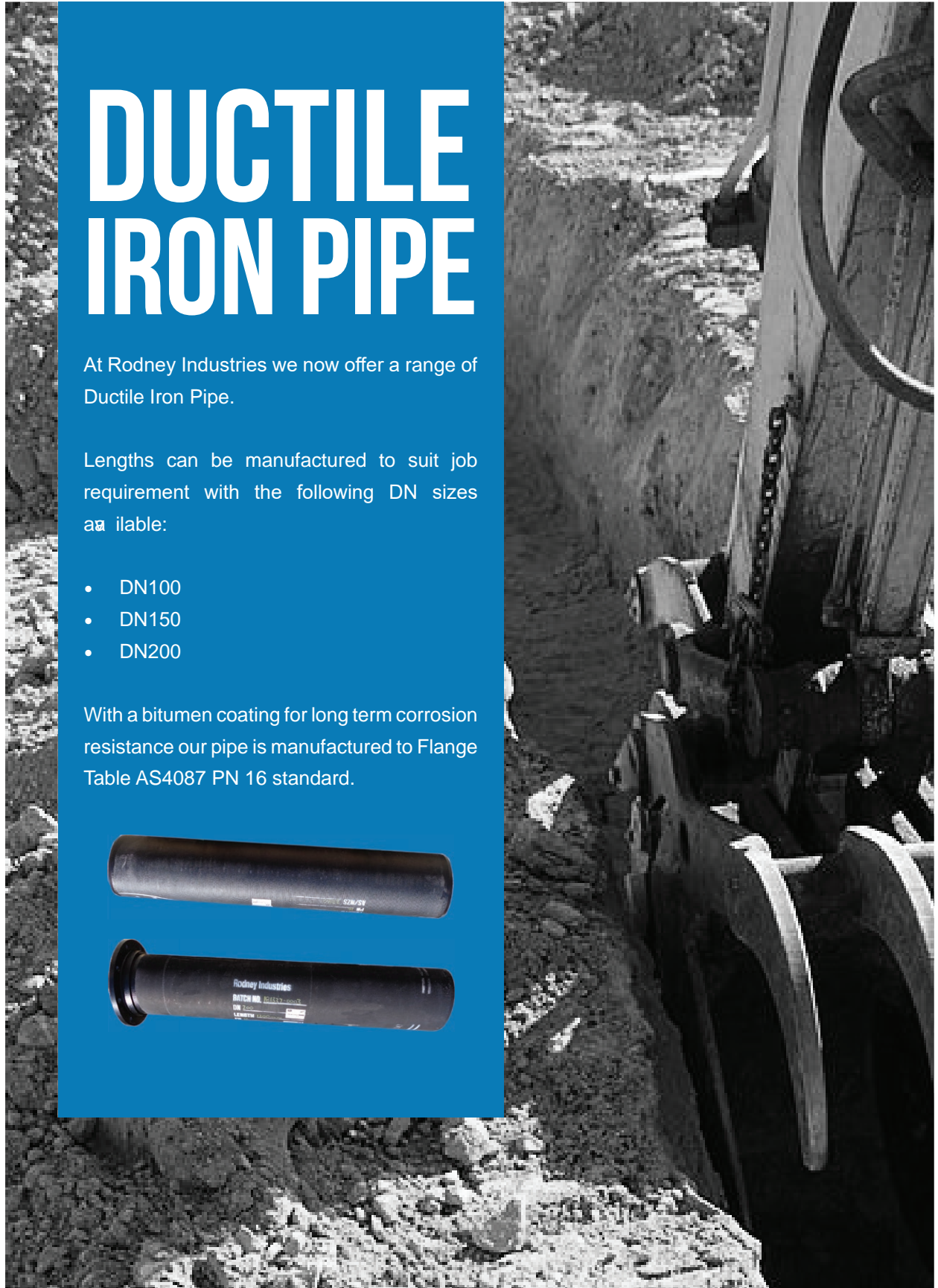



Rodney Industries

# TRUCK FILL STANDPIPE



## FEATURES

- Manufactured to your requirements
- Heavy duty design
- Hot dipped galvanized
- Component lifting points
- Ease of assembly
- Easy to transport



# RODNEY INDUSTRIES FABRICATION

With the ability of combining expertise of both Metals and Poly fabrication, we are able to custom fabricate a wide range of products to suit your requirements.



## CAPABILITIES



## METALS

- Custom piping, manifolds, strainers and fitting manufactured to customer specifications.
- MIG and TIG stainless and aluminium welding
- Rolling, folding and guillotining of sheet and plate
- Profile cutting to 100mm
- Steel laser cutting to 12mm, Stainless Steel cutting to 6mm
- Saw cutting to 500mm Dia
- CNC turning, milling and drilling



## POLY

- Fabricated Tees and Bends up to 800mm
- Butt Welding 63mm-1000mm
- Extrusion welding
- Sweep Bends:
  - Up to 92° capabilities
  - Size range 32mm - 355mm
  - SDR 21 - SDR 11 available
  - Accurate to 1°



Rodney Industries

# OUR 'FAB' CREATIONS



Steel Suction Manifold



Footvalve with Squat Strainer



Eco Check Valve



Poly Pontoon with Galv Support Frame



Custom StormPRO Junction



Poly Manifold





**Rodney Industries**

A Division of Vinidex Pty Ltd

19 Valente Close  
Chermside QLD 4032  
Tel: +61 7 3624 0300  
Fax: +61 7 3624 0399

Email: [sales@rodneyind.com.au](mailto:sales@rodneyind.com.au)  
Web: [www.rodneyind.com.au](http://www.rodneyind.com.au)